

ESTA

Operating manual



DUSTOMAT-160 S

DUSTOMAT-160 S	Art no.: 74020
DUSTOMAT-160 S	Art no.: 74021



Do not use this product unless you have read and understood the assembly instructions beforehand.

Translation of the original operating instructions
74020-08-00

Legal notice

Translation of the original operating instructions

Document no.: 74020-08-04

Publishing date: 16 April 2021

Device type: Mobile dust extractor DUSTOMAT-160 S

Item no.: 74.020 and 74.021

Document history

Version	Date	Change
00	16 April 2021	Document based on template 09506-08-04, texts adapted according to schematic 08-02-00

Issued by

ESTA Apparatebau GmbH & Co. KG
Gotenstr. 2-6
89250 Senden, Germany
Germany

Tel.: +49 (0) 73 07 80 4 - 0
Fax: +49 (0) 73 07 80 4 - 500
E-mail: info@esta.com
Web: www.esta.com

Copyright notice per DIN ISO 16016

The transfer and reproduction of this document, or the use or communication of its content, is forbidden without explicit consent. Violations shall be liable for damage compensation. All rights to patent, utility or design registration are reserved.

The warranty can only be accepted if the following conditions are met:

- Professional transport
- Professional assembly, commissioning and operation using these operating instructions.
- Verifiable compliance with the prescribed maintenance intervals.
- Operation of the product with conveyed media having the specified chemical and physical properties.
- Immediate reporting of damage to the manufacturer.
- Exclusive use of genuine replacement parts.
- Structural modifications to the original condition only to be carried out with the agreement and written approval of the manufacturer.

Contents

Contents	3
1. General instructions	5
1.1 General notes prior to use.....	5
1.2 Legal issues.....	5
1.3 Target group of the document.....	5
1.4 How to read this document.....	6
1.5 Form and significance of warning information.....	6
2. Product identification	7
2.1 Intended use.....	7
2.2 Improper use.....	7
2.3 Foreseeable misuse.....	8
2.4 Warranty conditions.....	8
2.5 Important information on the product.....	8
3. Safety	9
3.1 Symbols and labels used.....	9
3.2 Fire hazard prevention.....	9
3.3 Preventing electrical hazards.....	9
3.4 Preventing mechanical hazards.....	10
3.5 Preventing dust hazards.....	10
3.6 Workplace ventilation.....	11
3.7 Product safety.....	11
3.8 Qualified personnel.....	12
4. Structure and function	13
4.1 Representation.....	13
4.2 Functional description.....	14
4.3 Thorough electrical conductivity.....	14
5. Transport and installation	15
5.1 Transport.....	15
5.2 Set-up.....	16
6. Commissioning	17
6.1. Electrical connection.....	17
6.2 Connection.....	18
6.3 Operating and display elements.....	18
6.4 Rotation direction monitoring.....	19
7. Servicing & maintenance	20
7.1 Operating and auxiliary materials.....	21
7.2 Inspection and maintenance intervals.....	22
7.3 Changing the filter.....	23
7.4 Changing the paper bag.....	23
7.5 Monitoring the minimum air volume flow.....	24
7.6 Checking conductivity.....	24
8. Faults and Rectification	25
9. Decommissioning and disposal	26
9.1 Decommissioning.....	26
9.2 Storage.....	26
9.3 Disposal.....	27
10. Technical data	28
11. Optional equipment	29
11.1 Start-up with potential-free contact.....	29
11.2 Extraction arm.....	30
11.3 Floor cleaning set.....	30
11.4 Pre-separator.....	31

11.5	Throttle valve	32
11.6	Discharge air collection.....	32
12.	EC - / EU - Declaration of conformity	33
Notes	34
Notes	35

1. General instructions

1.1 General notes prior to use

Before using the product, it must be ensured that all persons about to use the product or perform maintenance work on it.

- Have received all relevant information, instructions and training courses for using the product and have understood them.
- Are able to perform or fulfil their tasks according to the law and the current operating manual.

1.2 Legal issues

The product's design and construction meets the directives and standards of the Declaration of Incorporation (According to MRL 2006/42/EC, Annex II Par 1 B) to minimise any possible potential risks originating from the product. Potential risks can only be minimised when the user or its authorised representative adheres to the additional, relevant standards for a product ready to install.

1.3 Target group of the document

This document is intended for operators trained on the product who are familiar with the extraction process.

- Trained assembly and maintenance personnel
- Trained electrical specialists

1.4 How to read this document





This document is a component of the product it describes. Keep the instructions easily accessible at the place where the device is being used, so that they can be seen by the staff at all times.

All persons must carefully read this document before any work on the product takes place (commissioning, assembly, maintenance, etc.). Prerequisite for safe work and trouble-free handling is that all relevant information, instructions and training for the use of the product and substances it is used for have been obtained and understood. The tasks must be performed or fulfilled according to the law and in accordance with this document.

Please follow the safety and warning instructions in the document and on the product. All plant, operating, and work instructions of the owner-operator apply in addition to this document.

The document also contains graphical examples along with the descriptions. The equipment may differ somewhat from the descriptions and representations

1.5 Form and significance of warning information

	<p>DANGER High risk of severe damage indicates an imminent hazard. If this is not averted, death or very serious injury will result</p>
	<p>WARNING Moderate risk of severe damage indicates the possibility of an imminent hazard. If this is not averted, death or very serious injury may result.</p>
	<p>CAUTION Risk with minor damage indicates the possibility of an imminent hazard. If this is not averted, slight or minimal injury may result.</p>
	<p>NOTE Material damage Foreseeable material damage for the product and environment with a failure to comply with the specified measures.</p>

This warning is displayed when there is a thread of danger or damage. This represents actions which can cause a risk of damage.

Warnings are indicated by a symbol or signal word. The warning includes information on the type and source of the hazard, the consequences if it occurs, and actions for averting it.

2. Product identification

2.1 Intended use

The product was designed for use at the following workplaces:

- Individual work station
- Group work station
- Rooms with several work stations

Coordinate any deviating applications with the manufacturer to ensure that the functioning of the product is not compromised.

The product has been manufactured based on state-of-the-art technology and according to recognised safety regulations and must be used appropriately and as follows:

- For commercial use, such as in industrial enterprises and workshops
- For the extraction of dry, sticky and long-fibre dust
- For the extraction of non-flammable dust
- Only for dry cleaning.

Other applications or ones extending beyond these are considered to be improper use. ESTA shall not be liable for damages due to unintended use.

The manufacturer sets up the product according to the operator's information.

2.2 Improper use

The product may only be used within the scope of the technical data specified by ESTA. Uses that exceed the specifications in "Intended Use" are deemed to be inappropriate. The manufacturer is in this case not liable for resulting damage.

Examples of inappropriate use are:

- Using or storing the product outdoors
- Change in the location during operation
- Use in dust or gas EXPLOSION areas
- Connecting to processing machines that may produce active ignition sparks or hot embers
- Extraction of corrosive gases
- Extraction of highly flammable or glowing particles
- Extraction of moist or fluid substances
- Installation in paint shops
- Installation in food operations

2.3 Foreseeable misuse

The use of the product in an unintended way, but which can arise from easily foreseeable human behaviour.

This includes:

- Outdoor installation without suitable on-site measures
- Installation or operation in explosive dust and gas environments
- Unauthorised modifications to the product
- Intake of glowing embers such as, e.g., cigarettes
- Start-up of the product despite defects detected on the product or attached parts (e.g., pipeline)
- Intake of items not suitable for suction (e.g., mobile phone, tool, glove, screws, etc.)
- Closing of intake opening

2.4 Warranty conditions

ESTA accepts no liability for damages and consequential damages to products or for personal injuries if the product is not used for its intended purpose. The operating company must prove that the fault was not caused by inappropriate installation, assembly, maintenance or use of the product.

For your own safety, use only genuine replacement parts and accessories. If other products are used, ESTA shall be released from any liability for resulting damage.

2.5 Important information on the product

Responsibility must be clearly stipulated for the following tasks:

- Transport
- Installation
- Commissioning
- Operation
- Maintenance and repair
- Cleaning
- Decommissioning
- Disposal

3. Safety

3.1 Symbols and labels used



ESTA maintenance stickers show when and by whom the last maintenance was carried out and when maintenance is next planned by the ESTA maintenance service.

3.2 Fire hazard prevention

	DANGER
	<p>Danger of fire due to sparks and glowing particles Severe injury including death possible</p> <ul style="list-style-type: none"> Keep combustible, flammable materials away from the work area. Never run away if clothing catches fire. Extinguish flames by rolling on the ground or by smothering them with blankets. If there is a fire, alert the fire department immediately, and contain the fire by appropriate means. Keep a suitable extinguishing agent (not included in scope of delivery) near the product before start-up and during operation. A corresponding fire protection concept must be created by the operating company.

3.3 Preventing electrical hazards

	DANGER
	<p>Electric shock from high voltage Severe injury including death possible</p> <ul style="list-style-type: none"> Any work on the electrical grid and on live components may only be performed by an electrician. Follow the safety rules for working on electrical products. Shut down the product or any live components at the main switch before working on them and secure them against reactivation (e.g. padlock). Establish electrical connections of the components according to the manufacturer's specifications. Regularly check the power cable for damage and wear. Keep covers closed during operation. Do not switch on the product if it or the power supply exhibits visible damage and secure it against reactivation (e.g. padlock). Have any damaged cable replaced by specialised staff.

After use, before moving the product to another site, and before cleaning, maintenance, or replacement or removal of movable parts, switch off the product at the main switch and secure it from reactivation (e.g. padlock).

3.4 Preventing mechanical hazards

	DANGER
	<p>Risk of injury posed by the drawing-in or entanglement of hair or loose items (e.g. chains, hair, ties, etc.)</p> <ul style="list-style-type: none"> Observe the safety regulations for work on products with rotating parts. Before working on the product, turn it off and secure it against unintentional reactivation. When working on the product, tie back long hair or wear a hairnet. When working on the product, do not wear any loose items (chains, ties).

	WARNING
	<p>Danger of crushing due to loose or open covers Injuries to limbs</p> <ul style="list-style-type: none"> Keep covers tightly closed during operation. Ensure that inspection doors are firmly closed. Check regularly that fastening screws and component connections are secure. Only start up the product after the assembly is complete and correct. Watch out for pipe or hose connections and other valves, or disconnect if required.

All movable machine parts driven by electric motors must be covered by fixed, securely fastened protective covers that can only be removed with tools.

3.5 Preventing dust hazards

	CAUTION
	<p>Toxic dusts Short-term impairment of the respiratory organs during inhalation</p> <ul style="list-style-type: none"> Maintenance, cleaning, repair, and emptying work may only be completed by expert personnel. Wear personal protective equipment. Ensure that the collection container is attached to the discharge opening. Ensure that inspection doors are firmly closed. Always complete all maintenance and upkeep work in a well-ventilated room. Seal the intake port with a sealing plug so it is dust-tight during transportation.

	CAUTION
	<p>Dust deposits in the pipe system Short-term impairment of the respiratory organs during inhalation</p> <ul style="list-style-type: none"> Check the connected piping system regularly for dust deposits. Observe the minimum air speed required for use and the resulting minimum airflow volume.

When opening and emptying the collection container, dust inhalation cannot be ruled out. That is why all servicing, cleaning and maintenance procedures, including the emptying of the collection container, are only to be performed by specialist personnel with personal protective equipment.

Personnel assigned to cleaning work must be instructed about the aspirated toxic materials. Harm to bystanders and the environment must be prevented by all means. After the maintenance has been carried out, the maintenance area must be thoroughly cleaned.

3.6 Workplace ventilation



The provisions of DGUV rule 109-002 must be complied with.

The operator must take air conditioning measures to ensure that the workplace ventilation requirements are met.

3.7 Product safety

The following points must be considered to avoid injuries and other risks due to inappropriate use and operation of the product:

- Assembly, electrical connection, maintenance, initial operation, cleaning, repair and other work in connection with the product may only be performed by trained specialists.
- The product must be checked for faulty or damaged supply lines (cables, pipe systems, etc.), connections and open system parts (inspection door, discharge opening). Do not use the product in such cases and immediately notify the maintenance personnel responsible.
- The product may only be operated when it is ready for operation, when the inspection doors are shut and when the toggle-type fasteners of the collection container are firmly closed.
- Ensure before any work is performed on the product or before inspection doors are opened that the product is disconnected from the power supply and secured against unauthorised reactivation.
- Connect the product to the electrical power supply properly and in precise compliance with the safety instructions and use it exclusively in accordance with the specifications.
- In all emergencies, the product must be disconnected immediately from the power supply, turned off at the main switch and the plug pulled immediately.

3.8 Qualified personnel

Trained personnel







Trained personnel are those who have been instructed in the correct handling of the product and who are aware of the risks presented by improper use. Personnel must receive instruction on safety equipment. Knowledge of this manual is mandatory.

Qualified semi-skilled technicians

An employee with appropriate technical training, knowledge and experience who is able to identify and avoid hazards. Knowledge of this manual is mandatory.

Trained skilled worker

Qualified technician in a qualified profession. Knowledge of this manual is mandatory.

Target group	Task	Qualification	Protective equipment
Transport personnel	Transport Set-up	Qualified semi-skilled technicians	
Assembly personnel	Installation	Trained skilled worker	
Commissioning personnel	Commissioning	Trained skilled worker	
Operating personnel	Operation	Qualified semi-skilled technicians	
Maintenance personnel	Inspection Maintenance Repair work	Trained skilled worker	
Maintenance, cleaning personnel	Maintain Cleaning	Trained personnel	
Electrical specialist	Troubleshooting	Trained skilled worker	

4. Structure and function

4.1 Representation

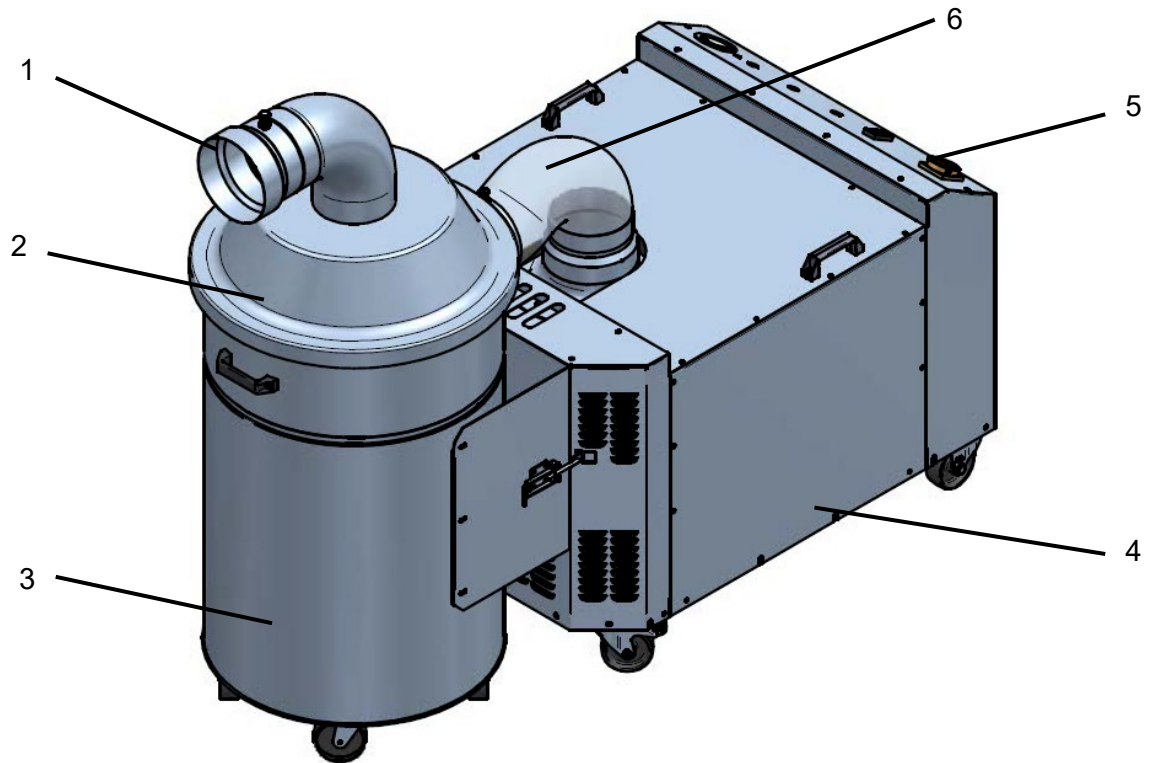

1	Suction opening port for the suction valves	4	Fan housing with air outlets
2	Removable maintenance cover for filter change	5	Operating and display elements
3	Mobile dust collection container for detachment	6	Clean air outlet to the fan

4.2 Functional description

The DUSTOMAT-S is equipped with a three-phase motor which drives a radial fan.

The vacuum created by the fan sucks in air via the suction hose connected to the intake port.

A permanent filter (cotton filter bag with an upstream paper bag) separates the dust from the air. The purified air is guided back into the room through the exhaust slots.

The product is equipped with a manometer as a control device for minimum flow volume. This control device measures the vacuum developing after the filter. The flow resistance increases with increased filter soiling from the dust and with it, the vacuum after the filter. The paper filter must be replaced if the area marked for the suction diameter on the manometer is reached at the latest.





To dispose of the filled dust collection bag, the upper part can be lifted upwards and the dust collection bag removed from the device.

4.3 Thorough electrical conductivity

A continuous electrical connection of all easily touchable metal parts which are not a component of the electrical operating circuit (thus inactive) is established to earth. Prevents a high contact voltage on electrically conductive device parts (e.g. housings) in the event of a fault.

5. Transport and installation

5.1 Transport

	<p>DANGER</p> <p>Risk of falling and tripping Danger to life from falling objects or loads</p> <ul style="list-style-type: none"> • Do not stand under suspended loads. • Secure the assembly area and mark it out (e.g., with barrier tape). • Always lift the product vertically during loading and assembly work. • Only transport the product with suitable, approved means of lifting and transport. • Do not place the product on a sloping surface. • Wear personal protective equipment. • Observe the local accident prevention regulations. 	
	<p>WARNING</p> <p>Crushing hazard when setting the product down Injuries to the hands and feet</p> <ul style="list-style-type: none"> • Secure the product against tipping and falling during transport. • Set the product down carefully and cautiously during set-up. • Wear work gloves and safety shoes. 	
	<p>NOTE</p> <p>Material damage due to improper transport Damage to the housing, lines and product components</p> <ul style="list-style-type: none"> • Do not push or pull the product across the floor if it does not have any rollers. • Seal the intake port with a sealing plug so it is dust-tight during transportation. • Pay attention to any protruding components when setting down the product. • Note the centre of gravity (which is not in the centre) when setting down the product. • Make sure that the surface can be driven on, is level and sufficiently load bearing. 	

The product is delivered fastened to a pallet. Following removal of the protective covers and the floor fixing, the device can be lifted using a forklift truck.

Do not use a crane.

1. Remove the packaging and check the product for damage and completeness
2. The product must not be put into operation if there is damage, or if the delivery is incomplete. Contact ESTA in such cases
3. Any foreign objects inside the product must be removed before start-up.





5.2 Set-up

	NOTE
	<p>Damage to property and the environment Observe minimum load-bearing capacity of the substrate</p> <ul style="list-style-type: none"> Only install the product on a level, firm substrate with sufficient load-bearing capacity. Products that are stationary during use must be fastened to the floor with anchors or another appropriate means of fastening.

	NOTE
	<p>Avoid material damage due to electrostatic charge The operator must ensure that conductive extraction systems and conductive processing machines that are not earthed via the product are earthed on site and integrated in the building's equipotential bonding.</p>

1. Lift the product from the pallet using a forklift at the positions provided and set it down right next to the pallet.
2. Connect the product with the processing machine and extraction device.
3. The product is ready for further connection.

6. Commissioning

 	WARNING	 
	<p>Danger of crushing due to loose or open covers Injuries to the limbs</p> <ul style="list-style-type: none"> • Keep covers tightly closed during operation. • Ensure that inspection doors are firmly closed. • Check regularly that fastening screws and component connections are secure. • Only start up the product after the assembly is complete and correct. • Watch out for pipe or hose connections and other valves, or disconnect if required. 	

	NOTE
	<p>Avoid material damage due to electrostatic charge The operator must ensure that conductive extraction systems and conductive processing machines that are not earthed via the product are earthed on site and integrated in the building's equipotential bonding.</p>

	NOTE
	<p>Material damage</p> <ul style="list-style-type: none"> • Inspect the product before each use for faulty, damaged or missing components. • If there is damage, do not use the product and immediately notify the maintenance personnel responsible.

6.1. Electrical connection

	DANGER
	<p>Electric shock from high voltage Severe injury including death possible</p> <ul style="list-style-type: none"> • Follow the safety rules for working on electrical products. • Secure the main switch against reactivation with a padlock when working on the product. • All work on the electrical mains and on live parts must only be performed by an electrician.

	NOTE
	<p>Observe rating plate Before establishing cable connections between the product and the mains, check whether the operating voltage specified on the rating plate matches that of the mains.</p>

The connection to the building's power supply is established at the installation location by the customer.

The mains plug may only be plugged in after the product has been set up in its installation location:

- Schuko standard wall socket 16 amp. slow

6.2 Connection

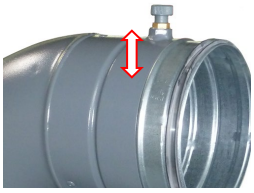

The product is set up with a connecting piece (reducer, muffle, etc.) with drill hole. As a result, the connection piece is locked via a locking bolt. The drill hole must be in line with the locking bolt position.

The appropriate, electro-conductive ESTA suction hose fixed to a connector is inserted into the port and locked with the locking bolt.

The connection is made to a processing machine that has a smaller port diameter by using a reducer that fits the extraction hose and is chosen to fit the port diameter of the machine creating the dust. Pay attention to the electrical conductivity between the connections.

After connecting the suction hose to the processing machine, the dust extractor is started first, then the processing machine. When switching off, this sequence must be performed in reverse.

6.3 Operating and display elements



Main switch

Main switch for turning the product on and off. EMERGENCY-OFF switch, which can be secured with a lock against unintentional activation.



Extraction ON/OFF

Extraction is started/stopped on the control panel by means of the On/Off switch.



Rotating field control

The rotating field control light illuminates when the system is started, if the rotational direction of the fan is incorrect.



Manometer

The minimum volume flow is monitored via the manometer. The red marking on the scale shows when the maximum value of the minimum volume flow is reached.

6.4 Rotation direction monitoring

	DANGER
	Electric shock from high voltage Severe injury including death possible <ul style="list-style-type: none">• Follow the safety rules for working on electrical products.• Secure the main switch against reactivation with a padlock when working on the product.• All work on the electrical mains and on live parts must only be performed by an electrician.

	NOTE
	Possible material damage caused by incorrect fan rotation direction If the rotation direction is incorrect, the product heats up unacceptably. The volume increases, the airflow volume falls, and the product's suction performance deteriorates. Damage to the product cannot be ruled out. After first switching on the product, the fan impeller's direction of rotation must be checked.

1. Turn the product off at the main switch.
2. Compare the rotation speed of the fan impeller with the rotation direction arrow on the housing.
 - If the motor fan wheel is turning in the wrong direction, the motor must have its electrical polarity reversed.
3. Turn the product off at the main switch.
4. Have the phases of the phase reversing connector transposed by an electrical technician.
5. Switch on the product at the main switch.
 - ⇒ The product is ready for operation.

7. Servicing & maintenance

	DANGER
	<p>Electric shock from high voltage Severe injury including death possible</p> <ul style="list-style-type: none"> Any work on the electrical grid and on live components may only be performed by an electrician. Follow the safety rules for working on electrical products. Secure the main switch against reactivation with a padlock when working on the product. Before working on the product, disconnect it from the voltage supply.

	WARNING
	<p>Danger of crushing due to loose or open covers Injuries to the limbs</p> <ul style="list-style-type: none"> Observe the local accident prevention regulations. Only empty the collection container when the system is switched off.

	CAUTION
	<p>Toxic dusts Short-term impairment of the respiratory organs during inhalation</p> <ul style="list-style-type: none"> Maintenance, cleaning, repair, and emptying work may only be completed by expert personnel. Wear personal protective equipment. Ensure that the collection container is attached to the discharge opening. Ensure that inspection doors are firmly closed. Always complete all maintenance and upkeep work in a well-ventilated room. Seal the intake port with a sealing plug so it is dust-tight during transportation.

All maintenance work must be recorded in writing in the maintenance book provided. This must make clear the equipment inspected and, if necessary, the deficiencies found, along with the name of the inspector and the date of the inspection.

All maintenance tasks should be carefully performed within the given time-scales. Preventative maintenance of the components prolongs the life of the product. So does regular cleaning and preventative exchange of wearing parts.

Safety devices for prevention or removal of hazards (e.g. according to the 2009/104/EC work equipment user devices and TRGS 560) must be regularly maintained and inspected by an expert for safe and appropriate operation.

Shut down the product immediately if malfunctions and defects are discovered and notify the responsible maintenance and repair staff.

	<p>Conduct annual repeat examinations VDE 0701 – 0702, VDE 0600. Depending on the mode of operation, the time intervals could be shorter. In this process, the entire system must be checked for seamless functionality by trained specialist personnel. Keep written proof of the main annual inspection in the included maintenance book. The date of the inspection, detected deficiencies, and the name of the auditor must be indicated. The date of the next maintenance session can be read on the inspection plate installed on the product.</p>
---	--

For maintenance by qualified personnel, the product must be opened, cleaned and inspected at the given locations. During maintenance or repair work, all soiled objects that can no longer be adequately cleaned must be disposed of. Dispose of such objects in bags impermeable to dust in compliance with the applicable regulations and laws for disposal of such waste.

7.1 Operating and auxiliary materials

	<p>NOTE</p> <p>Material damage caused by aggressive cleaning agents and incorrect cleaning methods</p> <p>Damage to seals, surfaces or plastics on the product</p> <ul style="list-style-type: none">• Do not use any aggressive cleaning agents which might attack seals, surfaces or plastics.• Use damp disposable cloths for cleaning.• Use industrial vacuum cleaners approved for the application.• Do not use any sharp objects or cleaning material with a rough surface.
--	--

Maintenance work must be performed according to accident prevention regulations. The product must be disconnected from the mains and compressed air. The compressed air tank is still pressurised even if the compressed air supply is switched off.

7.2 Inspection and maintenance intervals

	NOTE
	<p>Adjusting the maintenance interval to the operating time The inspection and maintenance intervals specified here refer to normal application conditions. In difficult conditions, e.g. increased separation volume and extended daily operating hours, the specified intervals must be shortened.</p>

Maintenance work must be performed according to accident prevention regulations. The product must be disconnected from the mains and compressed air. The compressed air tank is still pressurised even if the compressed air supply is switched off.

		Daily Operator	Weekly Operator; specialist maintenance personnel	Monthly Specialist maintenance personnel	Half-yearly Specialist maintenance personnel	Annually ESTA Maintenance Service	In case of damage	As required
Whole product	Visual inspection	X						
	Clean			X				
Maintenance doors	Visual inspection	X						
	Replace	X					X	
Mains cable	Visual inspection	X						
	Replace						X	
Dust collection container fill level (regulations require that the container be emptied if it is more than 2/3 full)	Visual inspection		X					
	Empty and clean							X
Filter	Clean				X			
	Replace (after 2 years)						X	X
Trails of dust / deposits on air outlet openings	Visual inspection			X				
Minimum volume flow control (manometer)	Functional and visual inspection			X				
Sealing of the complete product	Functional check					X		
Volume flow	Measurement					X		
Vacuum	Measurement					X		
Power consumption	Measurement					X		

7.3 Changing the filter

	CAUTION
	Toxic dusts Short-term impairment of the respiratory organs during inhalation <ul style="list-style-type: none">• Maintenance, cleaning, repair, and emptying work may only be completed by expert personnel.• Wear personal protective equipment.• Always complete all maintenance and upkeep work in a well-ventilated room.

The device is equipped with a dust collection container with a cotton filter bag and a disposable paper bag.

Daily

Visual inspection:

- Condition of the filter elements
- Damage and level of soiling

Half-yearly

Clean the cotton filter every six months:

1. Beat out cotton filter or wash out under lukewarm water →Hand wash. Filter is not machine washable.
2. Only return the filter element in a dry state.

Every 2 years

Replace cotton filter after approx. 2 years.

7.4 Changing the paper bag

To check whether the dust collection bag is already full, wait about one minute after cleaning so that the cleaned dust can settle.

If the fill level is just below the envelope edge, change the paper bag. Since it is not known what types of dust are being extracted, it can be necessary to replace the dust collection container before it has reached its maximum fill level (high bulk density = high weight).

1. Switch off the product.
2. Lock the product casters in place.
3. Remove the cover.
4. Tightly seal the paper bag (e.g. cable ties).
5. Dispose of the paper bag in accordance with local regulations.
6. Insert a new paper bag.
→Paper bag changed

7.5 Monitoring the minimum air volume flow

The product can be used to extract chips and dust from processing machines with different diameters. In this process, one must ensure that the minimum airflow volume extracted is not fallen below. The minimum airflow volume depends on the size of the intake port of the machine creating the dust.

When operating, the minimum volume flow is monitored with the manometer.

The paper filter must be changed at the latest at the following type-dependent maximum negative pressure levels:

Type	ø D (mm)	V (m ³ /h)	Threshold (mbar)
DUSTOMAT 160-S	160	1450	41

7.6 Checking conductivity

The electrical conductivity of the device may be interrupted or damaged due to vibrations and corrosion. This must therefore be checked on the device regularly (at least annually). To do this, please proceed as follows:

- Check electrical conductivity at all measuring points.
- Check all grounding cables for corrosion; replace if necessary.
- Check all grounding cable fixings; retighten fixings if necessary.
- Perform checking measurements.

When connecting an electrically conductive suction hose, make sure that the electrical connection between the hose and the port is faultless.

8. Faults and Rectification

	DANGER
	<p>Electric shock from high voltage Severe injury including death possible</p> <ul style="list-style-type: none"> Follow the safety rules for working on electrical products. Secure the main switch against reactivation with a padlock when working on the product. All work on the electrical mains and on live parts must only be performed by an electrician.

	CAUTION
	<p>Toxic dusts Short-term impairment of the respiratory organs during inhalation</p> <ul style="list-style-type: none"> Maintenance, cleaning, repair, and emptying work may only be completed by expert personnel. Wear personal protective equipment. Ensure that the collection container is attached to the discharge opening. Ensure that inspection doors are firmly closed. Always complete all maintenance and upkeep work in a well-ventilated room.

Fault	Possible cause	Possible solution
The motor has interrupted / can no longer be activated	The motor protection tripped by excessive activation and deactivation of the device.	Allow the device to rest for approx. ½ hour; after which you can work with the device usually
Suction power weakens / or does not suck at all	Paper filter bag over-full Suction hose blocked	Change the paper filter bag In a vacuumed room, hold the hose vertically and knock out with a rubber mallet.
The vacuum display on the manometer remains on the threshold of the corresponding suction diameter despite the change of the paper filter.	The filter pores in the cotton filter are blocked	Wash or change the cotton filter

If the motor protection responds frequently, the device should be sent to ESTA for inspection.

9. Decommissioning and disposal

9.1 Decommissioning

	<p>CAUTION</p>
	<p>Toxic dusts Short-term impairment of the respiratory organs during inhalation</p> <ul style="list-style-type: none"> • Maintenance, cleaning, repair, and emptying work may only be completed by expert personnel. • Wear personal protective equipment. • Ensure that the collection container is attached to the discharge opening. • Ensure that inspection doors are firmly closed. • Always complete all maintenance and upkeep work in a well-ventilated room. • Seal the intake port with a sealing plug so it is dust-tight during transportation.

	<p>Find out about the local regulations for packaging and disposal and comply with them.</p>
---	--

Proceed as follows:

1. Clean off filter.
2. Take out the filter and package according to local regulations.
3. Empty the collection container.
4. Clean the product inside and out.
5. Securely fasten all loose hoses, pipes and cables on the product.
6. Dispose of everything according to local regulations.

9.2 Storage

Store the product in a dry room if it is not required for a longer period of time.

Storage temperature	[°C]	+5 ≤ ≥ +25
Air humidity	[%]	30 - 70

9.3 Disposal



NOTE

Contamination

Due to contamination of the extraction system with dust hazardous to health, the system or its parts cannot be returned to ESTA. Dispose of collected material and filter elements according to the country-specific and regional laws and regulations.

Proceed as follows:

1. Empty the dust collection container.
2. Dispose of the filter according to local regulations.
3. Take the removable parts, e.g. motor, fan, cover, etc., out of the product.
4. Package the product and the detachable parts as specified by local regulations.
5. Dispose of everything according to local regulations.

10. Technical data

NOTE
Differing technical data for special versions

The potentially differing technical data for special versions of the standard product can be found on the type plate.

We reserve the right to make technical changes.

DUSTOMAT-160 S		74020	74021
Connection voltage	[V]	400	220
Nominal frequency	[Hz]	50	60
Drive power	[kW]	3.0	3.0
Nominal current	[A]	6.3	11.0
Circuit breaker	[A]	C16	
Max. airflow volume	[m ³ /h]	1850	1850
Max. vacuum	[Pa]	4600	4600
Cotton filter surface	[m ²]	1.0	
Dust collection container	[litres]	200	
Connection diameter	[mm]	160	
Dimensions (LxWxH)	[mm]	1,653 x 782 x 1,380	
Weight	[kg]	200	
Max. sound pressure level**	dB(A)	73	
Production year		See rating plate	

** = The measurement surface sound pressure level was measured according to DIN EN ISO 3744 in an open area, at maximum volume flow, at a 1-m distance from the surface of the device, at a height of 1.6 m above ground. The sound power level was calculated from the measurement surface sound pressure level and the device dimensions in accordance with DIN EN ISO 3744.

11. Optional equipment

11.1 Start-up with potential-free contact

	DANGER
	Danger from unintentional activation of the product Severe injury including death possible <ul style="list-style-type: none">• Any work on the electrical grid and on live components may only be performed by an electrician.• Follow the safety rules for working on electrical products.• When working on the product, switch off all products connected to the potential-free contact at their main switch and secure them with a padlock against reactivation.• Isolate all products connected to the potential-free contact; e.g. pull all mains connectors.

An option for connection is start-up via an external potential-free contact between the product and the processing machine. The product is started or stopped by the processing machine. The external potential-free contact is connected to a plug connector at 1 and 2. The potential equalisation is connected to “protective earth”. Additional details are listed in the accompanying circuit diagrams.

The toggle switch must be set to “AUTO” for this operating mode.

As soon as the main switch is set to “ON”, the contacts of the product’s black socket carry live voltage.

During maintenance work on the connected processing machines and products or control units, the control line to the dust extractor must be disconnected. Set all main switches to the “0” position and secure with a padlock against unintentional start-up. Disconnect all mains connectors.

Always disconnect the power cable from the control box when performing maintenance work on the **dust extractor**. The main switch must be located in the “0” position and secured against unintended commissioning with a padlock. The dust extractor is to be disconnected from the mains.

When performing maintenance work on the connected **processing machine** and devices or control units, disconnect the power cable from the dust extractor; all main switches must be in the “0” position and are to be secured against unintended commissioning with a padlock if possible. Disconnect all mains connectors. If this is not possible, take all suitable measures to ensure that all machines are isolated voltage-free. This applies to all machines connected to the plant.

11.2 Extraction arm

The extraction arms are designed for the DUSTOMAT S with air-flow properties which flexibly & precisely target the dust sources. The stable position of the extraction opening can be easily adjusted by the external gas-pressure springs.

The following sizes are available:

Order no.	Scope of delivery	Connection size	Length	Application	
101529		Ø100	1.5 m	DUSTOMAT 100-S	
122029		Ø125	1.5 m	DUSTOMAT 120-S	
123029			3 m		
142029		Ø140	1.5 m	DUSTOMAT 140-S	
143029			3 m		
162029		incl. 1.5 m PU connection hose	Ø160	1.5 m	DUSTOMAT 160-S
163029				3 m	



11.3 Floor cleaning set

A floor cleaning set is available as an accessory for the DUSTOMAT 100-S:

Order no.	Scope of delivery	Connection size	Application
91.023	 <p>Floor suction nozzle on castors, 1m suction pipe with hand pipe, electrically conductive</p>	Ø100	Floor cleaning

11.4 Pre-separator

The DUSTOMAT S can be equipped with an upstream separator. This is used to collect large volumes of coarse dust to extend the service life of the filter cartridge. It is available in different sizes depending on the dust extractor used.

Order no.	Scope of delivery	Connection size	Application
95.100	 Mobile 200 litre vessel with pre-separating head, including a connection to the extraction unit	Ø100	Dry Heavy coarse extraction material and high dust accumulation
95.125		Ø125	
95.140		Ø140	
95.160		Ø160	
97.100	 Mobile 100/200-litre vessel with impact sheet for filling with water, including connection to the extraction unit	Ø100/100 litres	Flying sparks Water separator for extraction on processing machines with possible spark formation
97.125		Ø125	
97.140		Ø140	
97.160		Ø160	
20821100	 Cyclone with mobile 100-litre dust-collection container, including connection to the extraction unit	Ø100	Lightweight material Large volumes of lightweight materials, primarily chips and dust
20821125		Ø125	
20821140		Ø140	
20821160		Ø160	



ESTA Customer Service: +49 (0) 7307 804 - 0

11.5 Throttle valve



Optionally, the device can be set up with a throttle valve on the intake port.

The throttle valve is used for throttling the supply air, by means of which air volume flow and negative pressure can be controlled. This is actuated manually.

To move the throttle valve, proceed as follows:

- Carefully raise the handle.
- Turn the handle in the desired direction. In this process, note the markings for "AUF" (open) and "ZU" (shut).
- Lower the handle to the desired position so that the handle latches in.

11.6 Discharge air collection

Optionally, the device can be set up with discharge air collection. A discharge air connection piece is attached to the discharge air collection. Attach an appropriate pipe or hose to the discharge air connection piece to channel the discharge air away.

12. EC - / EU - Declaration of conformity

Name of manufacturer: ESTA Apparatebau GmbH & Co. KG
Address of manufacturer: Gotenstraße 2 - 6
89250 Senden, Germany

Responsible for documentation: ESTA Apparatebau GmbH & Co. KG
Gotenstraße 2 - 6
89250 Senden, Germany

We hereby declare that the design of the machine

Machine: Dust extractor for the collection, handling, and separation of dry, free-flowing dusts at individual dust sources
Series: DUSTOMAT
Type: DUSTOMAT-160 S

conforms to the following regulations:

2006/42/EC	EC – Machinery Directive
2014/30/EU	EU Electromagnetic Compatibility Directive

The protective aims of the **2014/35/EC Low Voltage Directive** have been accomplished in accordance with Appendix I, No. 1.5.1 of the 2006/42/EC Machinery Directive.

Applied harmonised standards:

DIN EN ISO 12100	Safety of machinery - Basic concepts, general principles for design
DIN EN ISO 13857	Safety of machinery - Safety distances to prevent danger zones from being reached by the upper and lower limbs
DIN EN 349	Safety of machinery - Minimum distances for preventing body parts from being crushed
DIN EN 60204-1	Safety of machinery – Electrical machinery equipment - General requirements
DIN EN 61000-6-1	EMC generic standard - Immunity for residential, commercial and light-industrial environments
DIN EN 61000-6-2	EMC generic standard - Immunity for industrial environments
DIN EN 61000-6-3	EMC generic standard - Interference for residential, commercial and light industrial environments
DIN EN 61000-6-4	EMC generic standard - Interference for industrial environments
DIN EN 61000-3-2	EMC limits – Limits for harmonic current emissions (device input currents ≤ 16 A per cable)
DIN EN 61000-3-3	EMC limits – limitation of voltage changes, voltage fluctuations and flickers in low-voltage public supply systems for devices and equipment with a rated current ≤ 16 A per cable, not subject to a special connection

Senden, 16/04/2021

Dr. Peter Kullitz
Managing Director



ESTA Apparatebau GmbH & Co. KG
Gotenstraße 2 - 6
89250 Senden/Ay, Germany



Tel.: +49 (0) 7307 804 - 0
Fax: +49 (0) 7307 804 - 500
E-mail: info@esta.com

www.esta.com